

# Background Suppression Photoelectric Switch



**HP350-G Series** | A distance-specific switch that suppresses background interference



- Detection occurs at the specified distance.
- Suppression of background: influence from metal such as aluminum or stainless steel in the background is suppressed.
- Influence from color variations in target object is suppressed.
- Red light produces a clearly visible spot.
- Small differential enables thickness detection.
- Click-action 6-revolution potentiometer

## CATALOG LISTING

Catalog listing	Detection distance	Light ON	Adjustable sensitivity	Connection	Cable	Supply voltage	Output mode
HP350-G1L	20 to 200mm	●	●	Preleaded	2m	DC10 to 30V	Open collector NPN
HP350-G2L		●	●	Preleaded	2m		Open collector PNP

## SPECIFICATIONS

Catalog listing	HP350-G1L	HP350-G2L
Detection method	Background Suppression	
Supply voltage	10 to 30 VDC (ripple voltage 10 % max.)	
Current consumption	30 mA or less	
Detection distance	20 to 200 mm	
Set distance	40 to 200 mm	
Target objects	Standard target objects	
Standard target object	200 × 200 mm white paper (white construction paper)	
Distance adjustment	6-revolution continuous potentiometer	
Differential	10 % or less (at detection distance)	
Operation mode	Light ON	
Output mode	Open collector NPN	Open collector PNP
Control output	Switching current: 100 mA max. (resistive load). Output voltage: 30 V max. Residual voltage: 2 V max. (at 100 mA switching current) with output short-circuit protection	
Response time	1 ms or less (for operation and return)	
Emitter LED	Red LED (wavelength 631 nm)	
Indicator	Output indicator (lit yellow when output ON)	
Ambient light immunity	5,000 lux max. for incandescent lamp, 10,000 lux max. for sunlight	
Operating temperature	-25 to +55 °C (without condensation)	
Operating humidity	30 to 85 % RH (without condensation)	
Storage temperature	-40 to +70 °C (without condensation)	
Dielectric strength	20 MΩ min. (at 500 VDC)	
Withstand voltage	1,000 Vac 50/60 Hz for 1 min between all electrically live metal and case	
Vibration resistance	10 to 55 Hz, 1.5 mm peak-to-peak amplitude, 30 min (5 min for each cycle) each in X, Y, and Z directions	
Shock resistance	500 m/s <sup>2</sup> 3 times each in X, Y, and Z directions	
Protective structure	IP67 (IEC standard)	
Connection method	Preleaded. Cable length: <b>HP350-□□□□</b> : 2 m, <b>HP350-□□□□-L05</b> : 5 m	
Mass	Approx. 55 g (preleaded, 2 m cable)	
Protection circuits	Reverse connection protection	

## DETECTION PRINCIPLE

Using triangulation as shown below, the position of the target object is determined based on the position of the image formed on the light-receiving element, which differs depending on the distance of the target object. The distance setting of the **HP350-G** is adjusted by moving the lens up and down with the potentiometer.

### Correlation between target object position and image formation position

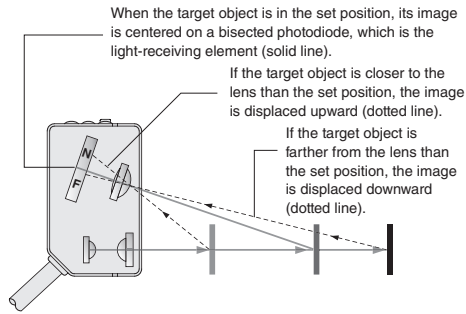

### Relationship of lens position and set distance

Turning the distance setting potentiometer moves the lens. If the set position is close, the lens is low, and if it is far away, the lens is high.

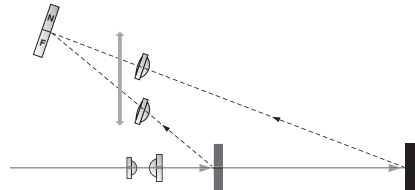

## CHARACTERISTICS DIAGRAM (REPRESENTATIVE EXAMPLE)

Distance characteristic chart for light projection spot lens

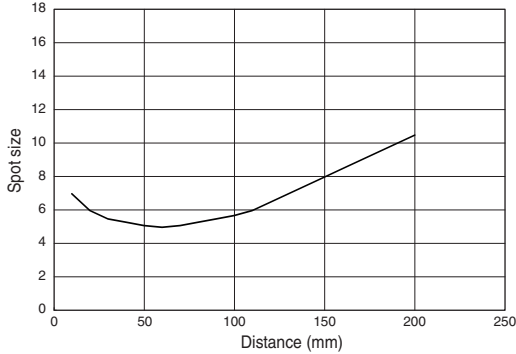

Detection area characteristic chart (when set at 100 mm)

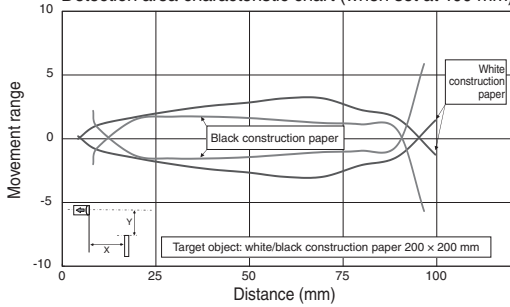

Detection area characteristic chart (when set at 200 mm)

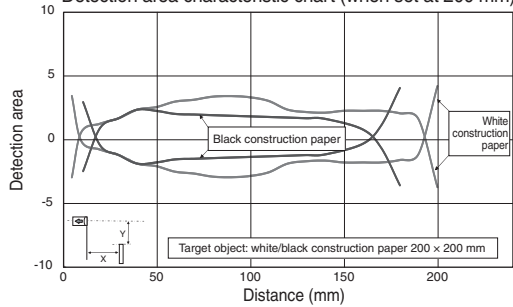

Differential – detection distance characteristic chart

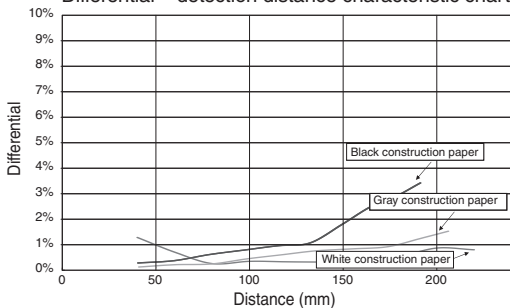

Detection distance – potentiometer rotation characteristic chart

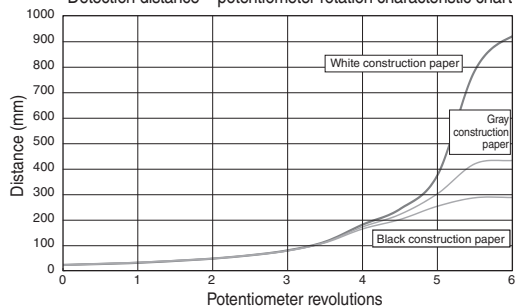

## CHARACTERISTICS DIAGRAM (REPRESENTATIVE EXAMPLE)

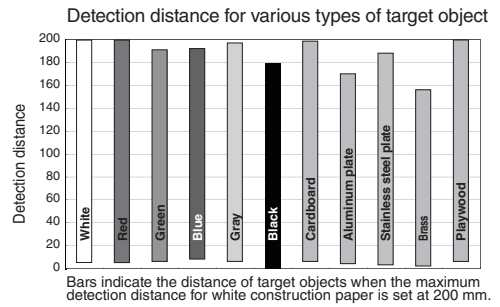
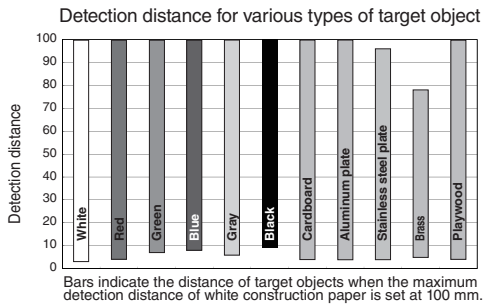

## EXTERNAL DIMENSIONS

(unit: mm)

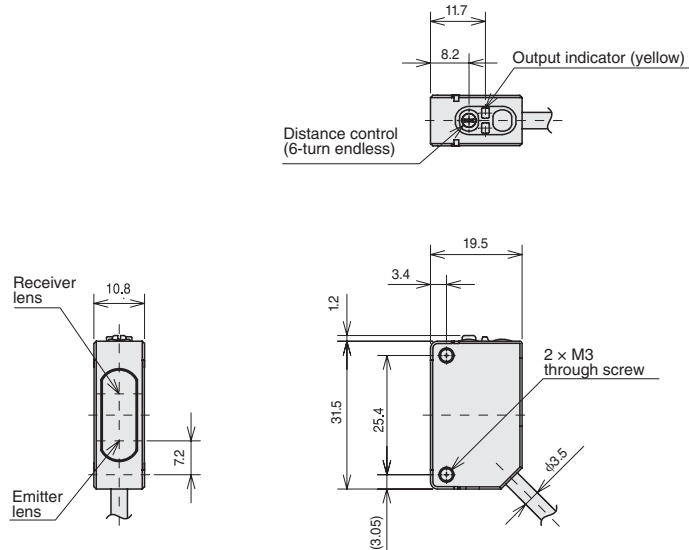

## OUTPUT CIRCUIT DIAGRAM

NPN type

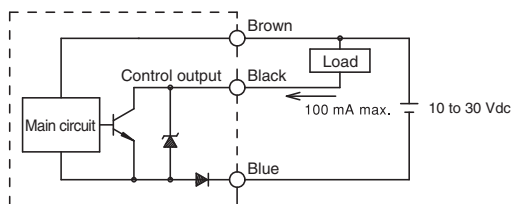

PNP type

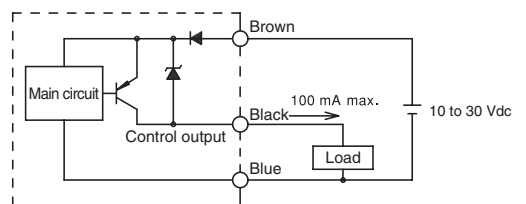

## NOTES FOR USE OF HP350G SERIES

### 1. Precautions for handling

- Tighten mounting screws to a torque of 0.5 N·m or less.
- It takes a maximum of 200 ms for the switch to operate after power is supplied.
- If the switch is installed outdoors, put it in a case so that it is not directly exposed to sunlight and rainwater.
- To prevent misalignment of the optical axis, do not install the switch where there is strong shock or vibration.
- Water on the lens can cause a malfunction. Install a shielding plate or the like to keep water off of the lens.
- Do not use the switch in a chemical atmosphere (organic solvents, acids, alkalis, etc.).
- If the switch is used in a location where there is strong ambient light, block the light with a hood, or change the orientation of the switch and then check that it functions properly.
- Prevent sunlight and fluorescent light (especially light from an inverter type fluorescent lamp) from directly entering the receiving element.
- When the switch is used in a dusty environment, take measures to prevent dust from accumulating on the sensing surface of the fiber unit, such as putting it in a sealed case and using an air purge.
- Do not use the switch where it is continuously exposed to water or where it could become immersed in water. Also, keep the ends of the cable from coming into contact with water.
- Never use the switch where it can be splashed with oil or coolant.
- The bending radius of the cable where it exits the switch body must be 30 mm or more. Also, do not use the cable in a manner that repeatedly subjects it to bending stress.
- Pulling the cable with excessive force may cause a disconnection.
- The photoelectric switch is assembled with high precision. Never hit an object against it. Be especially careful with the lens, as its characteristics will deteriorate if it is scratched or cracked.
- If the light-emitting or light-receiving surface become dirty, lightly wipe with a soft clean cloth, either dry or moistened with water. Do not use organic solvents such as alcohol, benzene, acetone, and thinner.
- If multiple photoelectric switches are used in close proximity, they may not operate reliably. After installation, be sure to carefully check switch operation before use.
- The relationship between the target object's direction of approach and the orientation of the switch should be as shown below.

○ → Right  
 × → Wrong

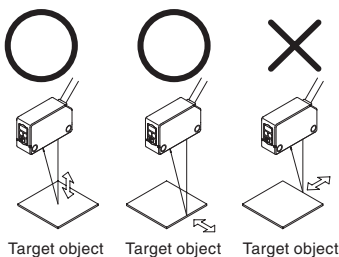

- The detection distance specification is 20 to 200 mm. Use the switch within this range.
- At low temperatures (0 °C or below), the cable will stiffen. If this happens, do not bend the cable or subject it to vibration or shock.

### 2. Precautions for wiring

- If it is necessary to extend the cable, use wire with a cross-sectional area of 0.3 mm<sup>2</sup> or more that is no longer than 100 m.
- If the wiring for the photoelectric switch is run through the same conduit as high-voltage or power lines, induction may cause malfunction or damage. Route the wiring in a different conduit or its own conduit.
- When using an off-the-shelf switching regulator, ground the frame ground and the ground terminal. Otherwise, switching noise may cause malfunction.
- When a load such as a capacitive load or an incandescent lamp is connected which results in an inrush current that exceeds the switching capacity, connect a current-limiting resistor between the load and the output terminal. (Otherwise, the output short-circuit protection may be activated).
- If strong surges occur in the power supply, connect a surge absorber to the power source.
- If the photoelectric switch breaks, there is a possibility of excessive current flow. Restrict current use to 3 A or less.

### 3. Adjustment method

Follow the procedures below to set the distance. (For dark-ON operation, replace “turn on” with “turn off,” and vice versa, in descriptions of the output indicator.)

Order	Distance setting potentiometer	Adjustment procedure
1		With the photoelectric switch and target object fixed in place, first turn the potentiometer counterclockwise until the output indicator turns off. From that position, turn the potentiometer clockwise. The position where the output indicator turns on is point A.
2		Next, remove the target object and check that the output indicator turns off. Turn the potentiometer clockwise from that position. The position where the output indicator turns on (detects the background) is point B.*1
3		The midpoint between points A and B is point C. Set the potentiometer to point C.*2

\*1. If the background is too far away to be detected, a position that is one clockwise revolution or more from point A should be used as point C.

\*2. Since this is a multi-revolution potentiometer, it may take more than one revolution to reach point B from point A.

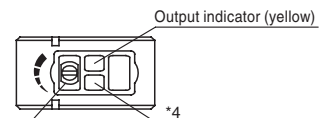

\*3. Distance setting potentiometer (6 revolutions, continuous potentiometer)

\*3. Turning clockwise sets a longer detection distance.

\*4. This switch is not equipped with a stability indicator.

Before use, thoroughly read the “Precautions for use” and “Precautions for handling” in the Technical Guide on pages A-141 to A-156 as well as the instruction manual and product specification for this switch.